

Bolts and Nuts

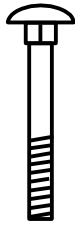

Hex-head bolt



Carriage bolt

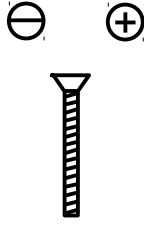

Machine bolt

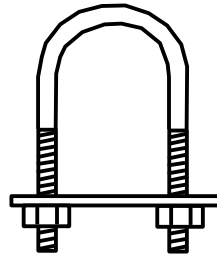

U bolt

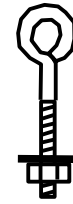

Eye bolt

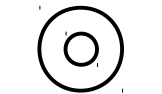

Flat washer



Hex nut



Wing nut

Miscellaneous



Duplex nail
"Hollywood"

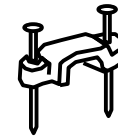

Cable staple

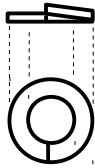

Lock washer



Square nut



T-nut

Screws



Drywall screw

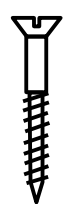

Flathead
Wood screws

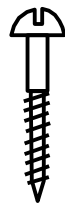

Roundhead



Pan-head
Sheet metal
screw

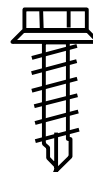

Tek
screw



Lag screw

Screw heads



Slotted



Phillips

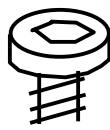

Allen



Robertson



Eye screw



Screw
hook

Hinges

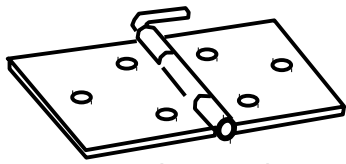

Loose-pin
Back-flap hinge

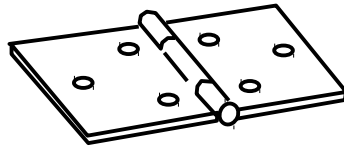

Tight-pin
Back-flap hinge

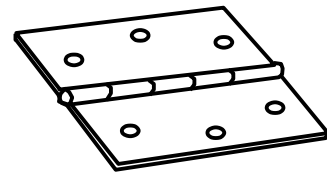

Butt hinge

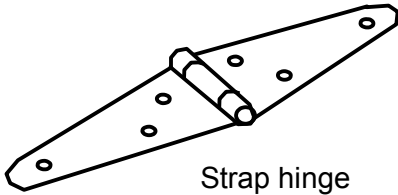

Strap hinge

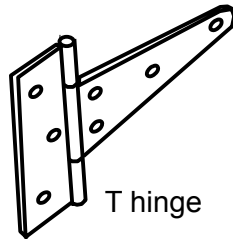

T hinge

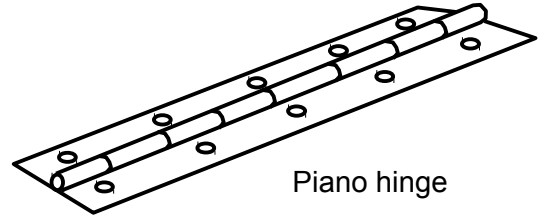

Piano hinge

Hardware

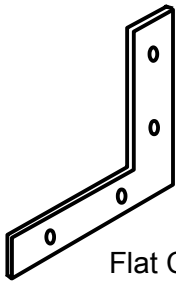

Flat Corner
iron

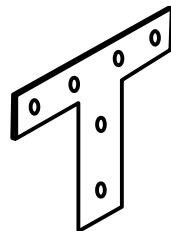

T iron

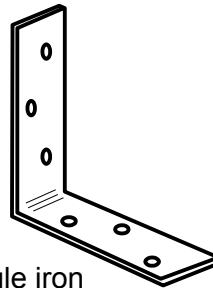

Angle iron

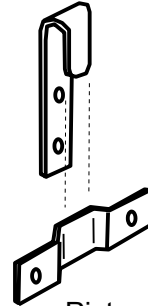

Picture hanger

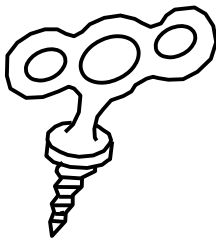

Stage screw

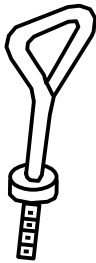

Improved
Stage screw

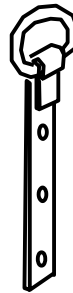

Top

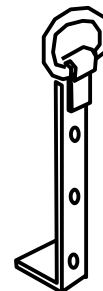

Bottom

Hanging irons

Rigging Gear



Shackle



Swage fitting

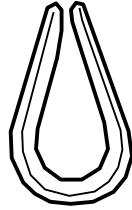

Thimble



Cable clip

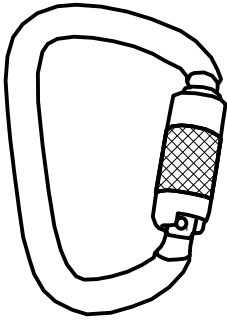

Carabiner

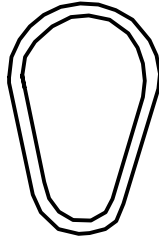

Pear ring

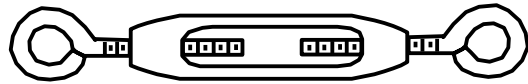

Turnbuckle

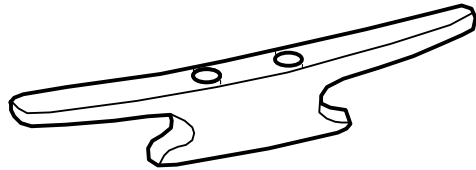

Belay cleat

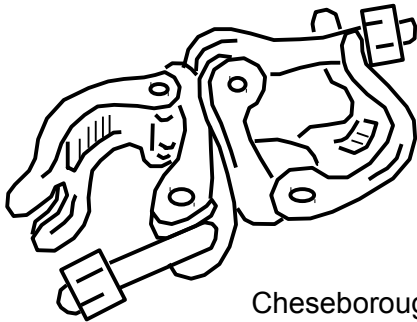

Cheseborough

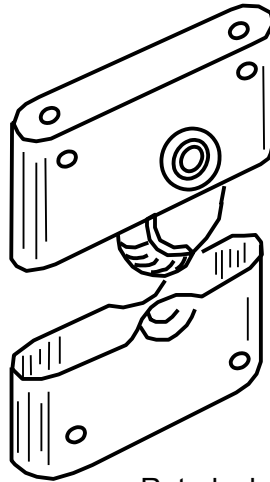

Roto-lock
a.k.a.
Coffin lock

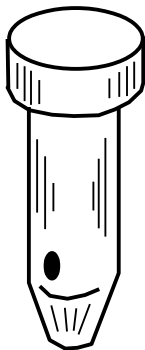

Hitch pin



R clip



Drift Pin

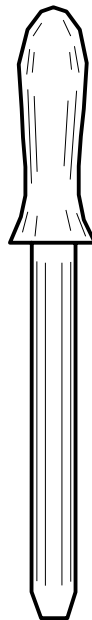

Belaying pin

TOOLS

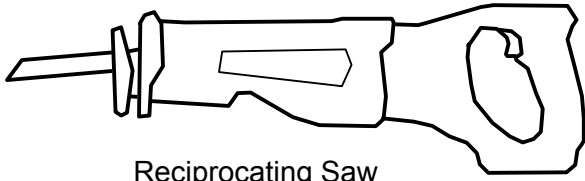

Reciprocating Saw

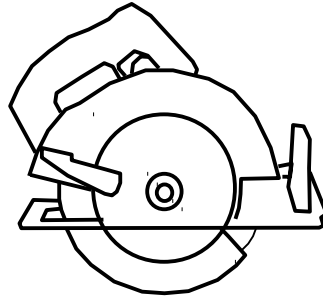

Circular Saw

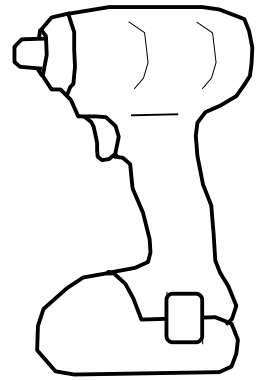

Impact wrench

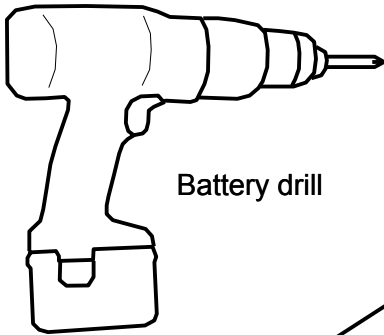

Battery drill

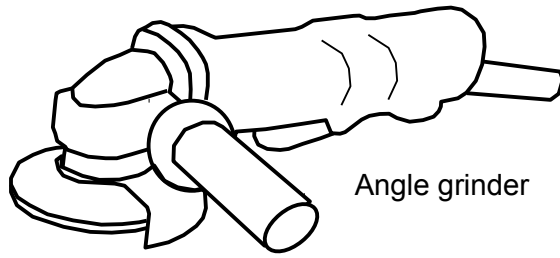

Angle grinder

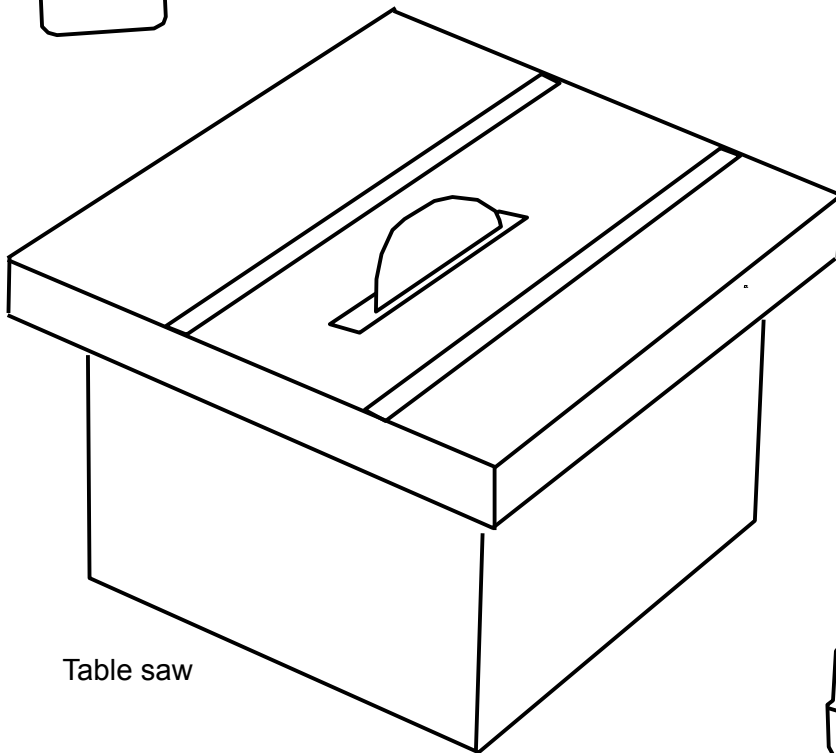
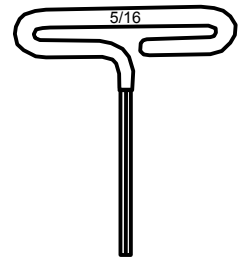
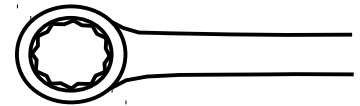

Table saw



T handle
Allan wrench



Box wrench

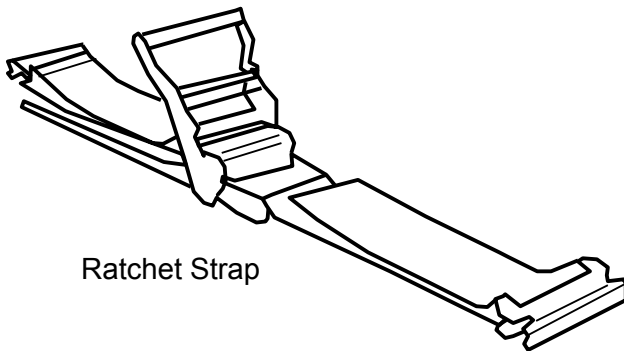

Ratchet Strap

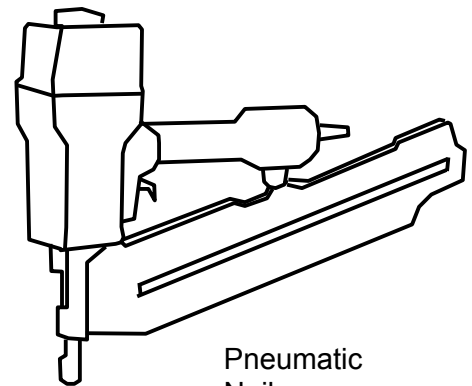

Pneumatic
Nail gun